

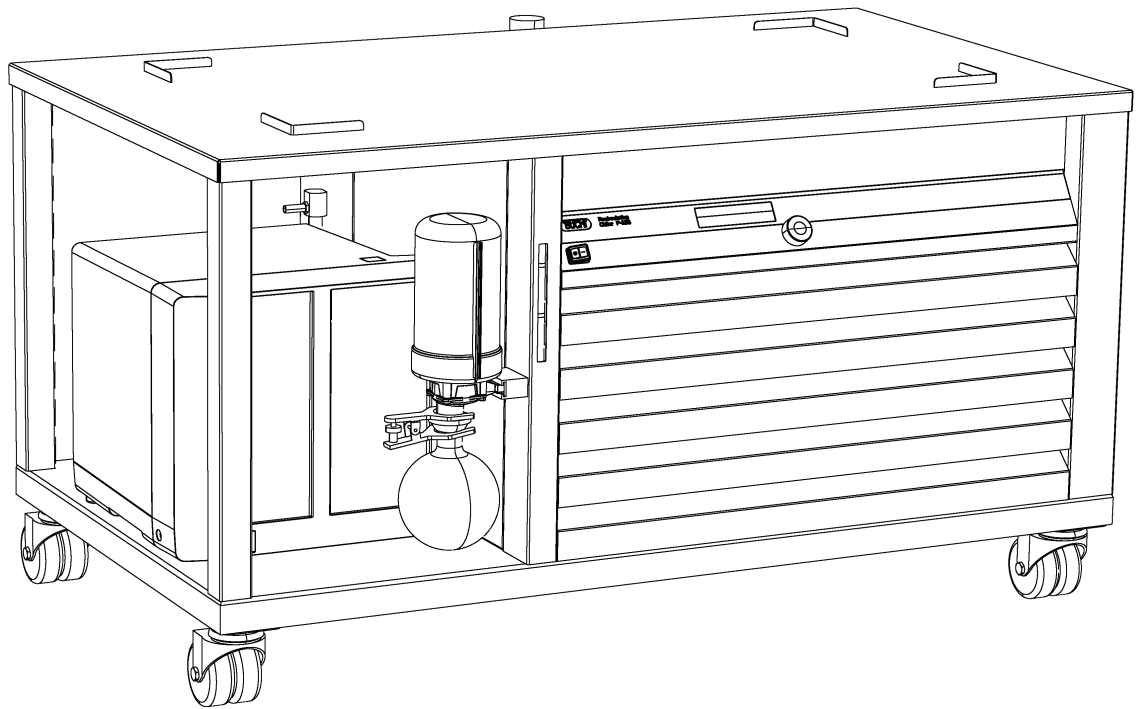

Recirculating Chiller F-325

Operation Manual



Imprint

Product Identification:
Operation Manual (Original), Recirculating Chiller F-325

11593909A en

Publication date: 02.2017

BÜCHI Labortechnik AG
Meierseggstrasse 40
Postfach
CH-9230 Flawil 1

E-Mail: quality@buchi.com

BÜCHI reserves the right to make changes to the manual as deemed necessary in the light of experience; especially in respect to structure, illustrations and technical detail.

This manual is copyright. Information from it may not be reproduced, distributed, or used for competitive purposes, nor made available to third parties. The manufacture of any component with the aid of this manual without prior written agreement is also prohibited.

Table of contents

1	About this manual	5
2	Safety.	6
2.1	User qualification	6
2.2	Proper use	6
2.3	Improper use	6
2.4	Safety warnings and safety signs used in this manual	7
2.5	Product safety.	9
2.5.1	General hazards.	9
2.5.2	Personal protective equipment	10
2.5.3	Built-in safety elements and measures	10
2.6	General safety rules	11
3	Technical data	12
3.1	Technical data.	12
3.2	Materials used.	12
4	Description of function	13
4.1	Functional principle	13
5	Putting into operation.	14
5.1	Installation site.	14
5.2	Cooling water routing	15
5.3	Operating controls and housing	16
5.4	Electrical connections	17
5.5	Preparing for operation	18
5.5.1	Installing the Rotavapor® on top of the Chiller	18
5.5.2	Installing the hoses	19
5.5.3	Filling the cooling media tank	19
5.5.4	Installing the Vacuum Pump V-600	20
6	Operation	21
6.1	Operating the Recirculating Chiller.	21
6.2	Operating the Recirculating Chiller with the Interface I-300 Pro	21
6.3.	Locking the set temperature.	22
7	Maintenance and repairs	23
7.1	Customer service	23
7.2	General inspection and cleaning instructions	24
8	Troubleshooting	25
8.1	Error message display.	25
8.2	Faults and rectifying them	25
8.2.1	Indication of faults on the display	25
8.2.2	Other malfunctions	26
9	Shutdown, storage, transport and disposal	27
9.1	Storage and transport.	27
9.2	Disposal.	28
10	Spare parts.	29
10.1	Enclosed parts	29
10.2	Instrument configuration.	29
10.3	Spare parts, optional accessories	30
11	Declarations and requirements.	31
11.1	FCC requirements (for USA and Canada)	31
11.2	Health and safety clearance	32

1 About this manual

This manual describes the Chiller and provides all information required for its safe operation and to maintain it in good working order.

It is addressed to laboratory personnel and operators in particular.

Read this manual carefully before installing and running your system and note the safety precautions in section 2 in particular. Store the manual in the immediate vicinity of the instrument, so that it can be consulted at any time.

No technical modifications may be made to the instrument without the prior written agreement of BUCHI. Unauthorized modifications may affect the system safety or result in accidents. Technical data are subject to change without notice.

NOTE

The symbols pertaining to safety (WARNINGS and ATTENTIONS) are explained in section 2.

This manual is copyright. Information from it may not be reproduced, distributed or used for competitive purposes, nor made available to third parties. The manufacture of any component with the aid of this manual without prior written agreement is also prohibited.

The English manual is the original language version and serves as basis for all translations into other languages. If you need another language version of this manual, you can download available versions at www.buchi.com or reorder manuals from a BUCHI representative.

2 Safety

This section introduces the safety concept of the instrument and contains general rules of behavior and warnings from direct and indirect hazards concerning the use of the product.

For the users safety, all safety instructions and safety messages in the individual sections shall be strictly observed and followed. Therefore, the manual must always be available to all persons performing any tasks described herein.

2.1 User qualification

The instrument may only be used by laboratory personnel and other persons who on account of training and professional experience know the potential dangers that can develop when operating the instrument.

Untrained personnel, or persons who are currently being trained, require careful supervision by a qualified person. This Operation Manual serves as a basis for training.

2.2 Proper use

The Recirculating Chiller is conceived and built as a piece of laboratory equipment. Its regulation use is the cooling of closed cycles (e.g. rotary evaporators, reaction vessels).

When the Recirculating Chiller is used in combination with an instrument (e.g. rotary evaporator and reaction vessels) all related manuals are to be fully observed.

The regulation use of the Recirculating Chiller also includes its care.

2.3 Improper use

Any other use than the one stated above and any application that does not comply with the technical data is considered to be improper use. Improper use can cause hazardous situations for the operator and / or for the instrument and might cause consequential property damage.

The operator bears the sole risk for any damages or hazards caused by improper use!



In particular, the following uses must not be permitted

- Installation or use of the instrument in rooms, which require ex-protected instruments.
- The use of spare parts or accessories other than those mentioned in these operating instructions.
- The equipment may not be operated using combustible substances.
- It is not permitted to put anything other than the 20 L Rotavapor® from BUCHI on top of the Recirculating Chiller F-325.

2.4 Safety warnings and safety signs used in this manual

DANGER, WARNING, CAUTION and NOTICE are standardized signal words for identifying levels of hazards and risks related to personal injury and property damage. All signal words, which are related to personal injury are accompanied by the general safety sign.

For your safety it is important to read and fully understand the table below with the different signal words and their definitions!

Sign	Signal word	Definition	Risk level
	DANGER	Indicates a hazardous situation which, if not avoided, will result in death or serious injury.	★★★★
	WARNING	Indicates a hazardous situation which, if not avoided, could result in death or serious injury.	★★★☆☆
	CAUTION	Indicates a hazardous situation which, if not avoided, may result in minor or moderate injury.	★★☆☆☆
no	NOTICE	Indicates possible property damage, but no practices related to personal injury.	★☆☆☆☆ (property damage only)

Supplementary safety information symbols may be placed in a rectangular panel on the left to the signal word and the supplementary text (see example below).





Space for supplementary safety information symbols.	 SIGNAL WORD
	Supplementary text, describing the kind and level of hazard / risk seriousness. <ul style="list-style-type: none"> List of measures to avoid the described hazard or hazardous situation.

Table of supplementary safety information symbols

The reference list below incorporates all safety information symbols used in this manual and their meaning.

Symbol	Meaning
	General warning
	Electrical hazard
	Heavy weight, avoid overexertion
	Explosive gases, explosive environment

Symbol	Meaning
	Fire hazard
	Harmful to life forms
	Hot item, hot surface
	Device damage
	Inhalation of substances
	Chemical burns by corrosives
	Cuts by sharp edges
	Flooding
	Wear laboratory coat
	Wear protective goggles
	Wear protective gloves
	To be carried by two persons

Additional user information

Paragraphs starting with 'NOTE' transport helpful information for working with the device/software or its supplementaries. NOTES are not related to any kind of hazard or damage (see following example).

NOTE

Useful tips for the easy operation of the instrument/software.

2.5 Product safety



The Recirculating Chiller has been designed and built in accordance with current state-of-the-art technology, at the time of development. Safety warnings in this manual (as described in section 2.4) serve to make the user alert to and avoid hazardous situations emanating from residual dangers by giving appropriate counter measures.

However, risks to users, property and the environment can arise when the instrument is damaged, used carelessly or improperly.



2.5.1 General hazards

The following safety messages show hazards of general kind which may occur when handling the instrument. The user shall observe all listed counter measures in order to achieve and maintain the lowest possible level of hazard.

Additional warning messages can be found whenever actions and situations described in this manual are related to situational hazards.

	<p>! DANGER</p> <p>Death or serious injuries when used in explosive environments.</p> <ul style="list-style-type: none"> • Do not store or operate the instrument in explosive environments • Remove all sources of flammable vapors • Do not store chemicals in the vicinity of the device
	<p>! CAUTION</p> <p>Risk of minor or moderate cuts by sharp edges.</p> <ul style="list-style-type: none"> • Do not touch defective or broken glassware with bare hands • Do not touch thin metal edges
	<p>NOTICE</p> <p>Risk of instrument damage by liquids or mechanical shocks.</p> <ul style="list-style-type: none"> • Do not spill liquids over the instrument or its components • Do not move the instrument when it is loaded with coolant • Do not drop the instrument or its components • Keep external vibrations away from the instrument • Do not operate the instrument without insulation panels and reflector

Safety messages regarding Refrigerant R134a:

	<p>! WARNING</p>
	<p>Danger of injury and material damage due to overheating.</p> <ul style="list-style-type: none"> • Keep at temperature not exceeding 45 °C
	<p>! WARNING</p>
	<p>Danger of corrosion and poisoning through inhalation of the fumes.</p> <ul style="list-style-type: none"> • In case of fire and/or explosion do not breathe fumes
	<p>! CAUTION</p>
	<p>Freeze-burns and eye injuries through direct contact with R134.</p> <ul style="list-style-type: none"> • Avoid contact with skin and eyes • Always wear safety goggles • Always wear safety gloves • Hoses can be additionally insulated (see optional offering for hose insulation)

2.5.2 Personal protective equipment

Always wear personal protective equipment such as protective eye goggles and protective clothing. The personal protective equipment must meet all requirements of all data sheets for the chemicals used. These instructions are an important part of the Recirculating Chiller and must be made available at all times to the operating personnel at the place where the equipment is installed.

	<p>! WARNING</p>
	<p>Serious chemical burns by corrosives.</p> <ul style="list-style-type: none"> • Always wear protective goggles • Always wear protective gloves • Always wear laboratory coat

2.5.3 Built-in safety elements and measures

The instrument is fitted with a thermal overload protection for the compressor. The minimum quantity of cooling liquid is controlled by a niveau sensor.

2.6 General safety rules

Responsibility of the operator

The head of the laboratory is responsible for training his/her personnel.

The operator shall inform the manufacturer without delay of any safety-related incidents which might occur during operation of the instrument or its accessories. Legal regulations, such as local, state and federal laws applying to the instrument or its accessories must be strictly followed.

Duty of maintenance and care

The operator is responsible for the proper condition of instrument. This includes maintenance, service and repair jobs that are performed, on schedule by authorized personnel only.

Spare parts to be used

Use only genuine consumables and spare parts for maintenance to assure good system performance, reliability and safety. Any modifications of spare parts or assemblies are only allowed with the prior written permission of the manufacturer.

Modifications

Modifications to the instrument are only permitted after prior consultation and with the written approval of the manufacturer. Modifications and upgrades shall only be carried out by an authorized BUCHI technical engineer. The manufacturer will decline any claim resulting from unauthorized modifications.

3 Technical data

This section introduces the reader to the Recirculating Chiller and its specifications. It contains the technical data, requirements and performance data.

3.1 Technical data

Technical data	
Power consumption (max.)	2200 W
Supply voltage	230 VAC \pm 10%
Fuse	16 AT
Frequency	50/60 Hz
Environmental conditions	For indoor use only
- Temperature	+5 – +35 °C
- Altitude	up to 2000 m
- Humidity	Maximum relative humidity 80% for temperatures up to 31 °C decreasing linearly to 50% relative humidity at 40 °C
Display	digital, resolution 0.1 °C
Overvoltage category	II
Degree of protection	IP20
Pollution degree	2
Instrument dimensions W x H x D	1070 x 580 x 650 mm
Weight	101 kg
Cooling power at 15 °C	2500 W
Refrigerant	R134a
Temperature range	-10 °C ... +25 °C
Hysteresis	\pm 1 °C
Tank volume	9 L
Hose connection	13.5 mm
Pump flowrate	14 L/min
Pump pressure	2.5 bar

3.2 Materials used

Materials used			
Component	Material designation	Material code	Hazardous substances
Stainless steel, powder-coated with polyester-epoxide	Housing	1.4301	–
Polyester	Lamina	PES	–
Glass-fiber-reinforced epoxy resin	Circuit board		–
Polyvinyl chloride	Cable	PVC	–
R134a	Refrigerant	1,1,1,2-tetrafluoroethane	Check MSDS

4 Description of function

This section explains the basic working principle of the Recirculating Chiller. It also shows how the instrument is structured and provides a general functional description of its assemblies.

4.1 Functional principle

The BUCHI Recirculating Chiller F-325 is a closed-circuit cooler for use with rotary evaporators. The F-325 has a control unit and display built in to regulate and indicate the actual and set value of the cooling temperature.

The Recirculating Chiller is designed for installation of a 20 L Rotavapor® from BUCHI on top of the instrument.

The environmentally-friendly refrigerant R134a is used as the refrigerating medium.

Process overview F-325

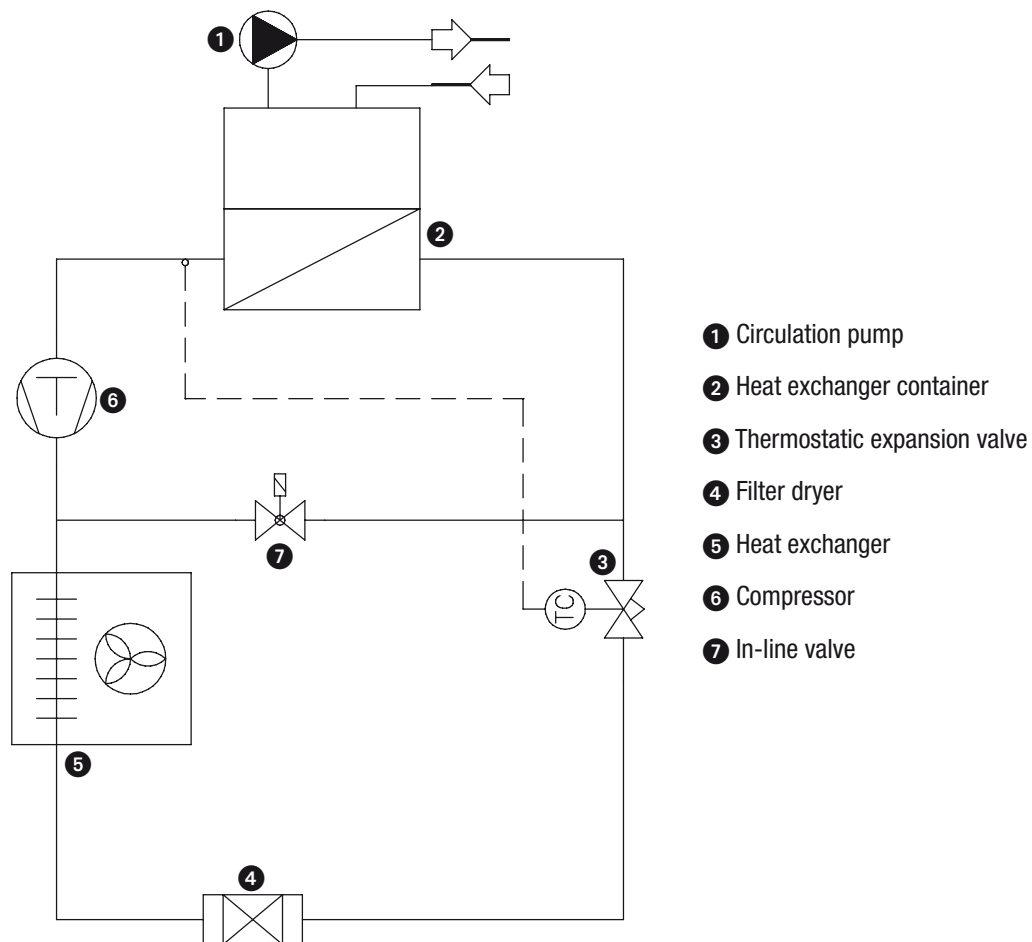

5 Putting into operation

This section describes how the instrument has to be installed. It also gives instructions for the initial start-up.

NOTE

Inspect the instrument for damage during unpacking. If necessary, prepare a status report immediately and inform customer support and your local BUCHI representative. Keep the original packaging for future transportation.

Also adhere to all instructions concerning transport as described in section 9.1, Storage and transport.

To move the instrument, loosen the clamps of the wheels, move the instrument and afterwards secure the wheels by the clamps again.

5.1 Installation site



Put the instrument onto a clean, stable and horizontal surface. Consider the maximum product dimensions and weight. Obtain the environmental conditions as described in section 3.1, technical data.



Installation prerequisites and installation steps:

- Do not place any objects in front or behind the instrument.
- The instrument must have a clearance of 40 cm between itself and the wall, both in front and behind (sufficient cooling).
- Do not place containers, chemicals or other items behind the instrument.

NOTE

- *After transport, wait at least 1 hour before switching on the chiller! Within this time the refrigerant gathers in the compressor, avoiding damage to the compressor.*
- *To ensure that the power can be cut by unplugging in case of an emergency, the mains plug must not be blocked by the instruments or any other items!*
- *Depending on the environmental conditions, condensation water at the cooling tubes and all other cold surfaces of the instruments may collect!*

	 DANGER
	<p>Death or serious injuries when used in explosive environments.</p> <ul style="list-style-type: none"> • Do not store or operate the instrument in explosive environments • Remove all sources of flammable vapors • Do not store chemicals in the vicinity of the device

	 WARNING
	<p>Stumbling or falling due to improper installation of the cables and hoses.</p> <ul style="list-style-type: none"> • The length of the cables and hoses should be kept as short as possible • If possible, avoid installing cables and hoses in aisle areas • If installation of cables and hoses in aisle areas is unavoidable, use an adequate protective pad in order to avoid the danger of stumbling and damage

	! WARNING
	<p>Fire hazard, damage to the instrument through overheating due to inadequate air circulation.</p> <ul style="list-style-type: none"> • Do not cover the instrument • Minimum distance from other objects must be at least 40 cm

	! CAUTION
	<p>Risk of minor or moderate injury due to the heavy weight of the instrument.</p> <ul style="list-style-type: none"> • Utilize a second person to transport the instrument • Do not drop the instrument or its transport box • Place the instrument on a stable, even and vibration-free surface • Keep limbs out of crushing zone

5.2 Cooling water routing

Independent of the number of coolers, the cooling water inlet has to be connected in ascending order starting with the cooler closest to the receiving vessel. The cooling water outlet is always the upper connector.

Example (simplified schematic)

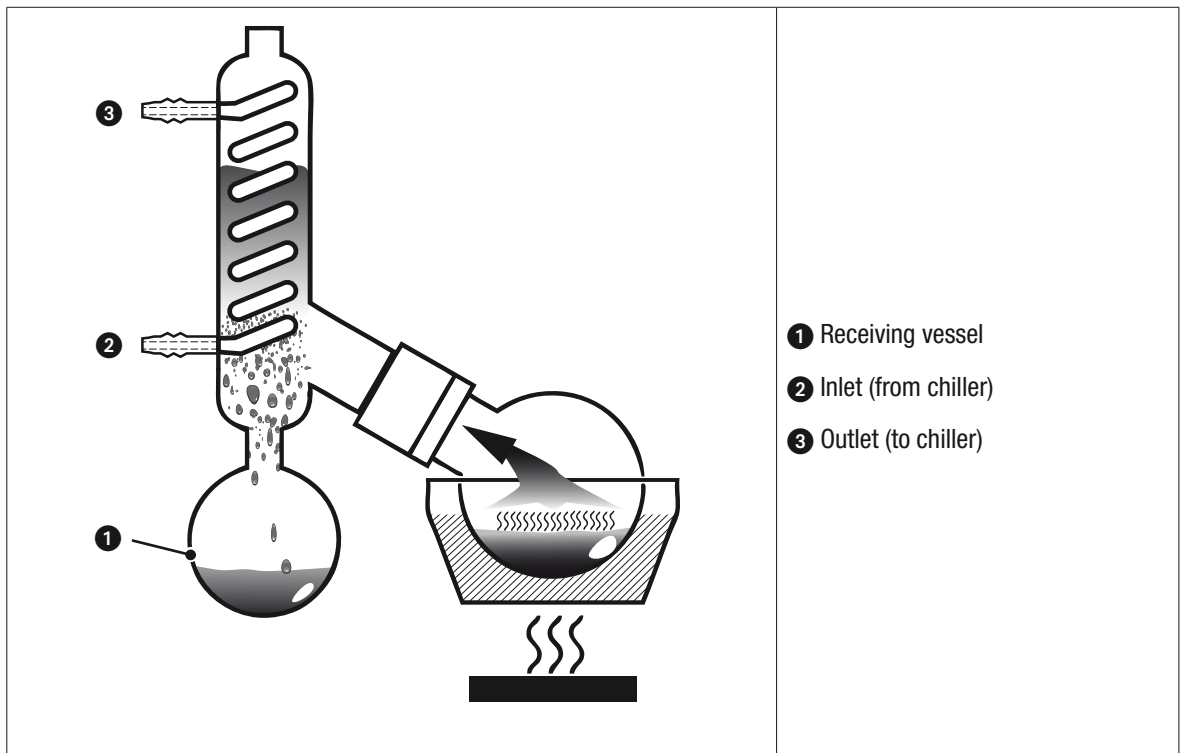

The drawing shows the cooling water routing for the setup of a single cooler. Other arrangements with single or double cooler setup can be connected accordingly.

5.3 Operating controls and housing

Front side

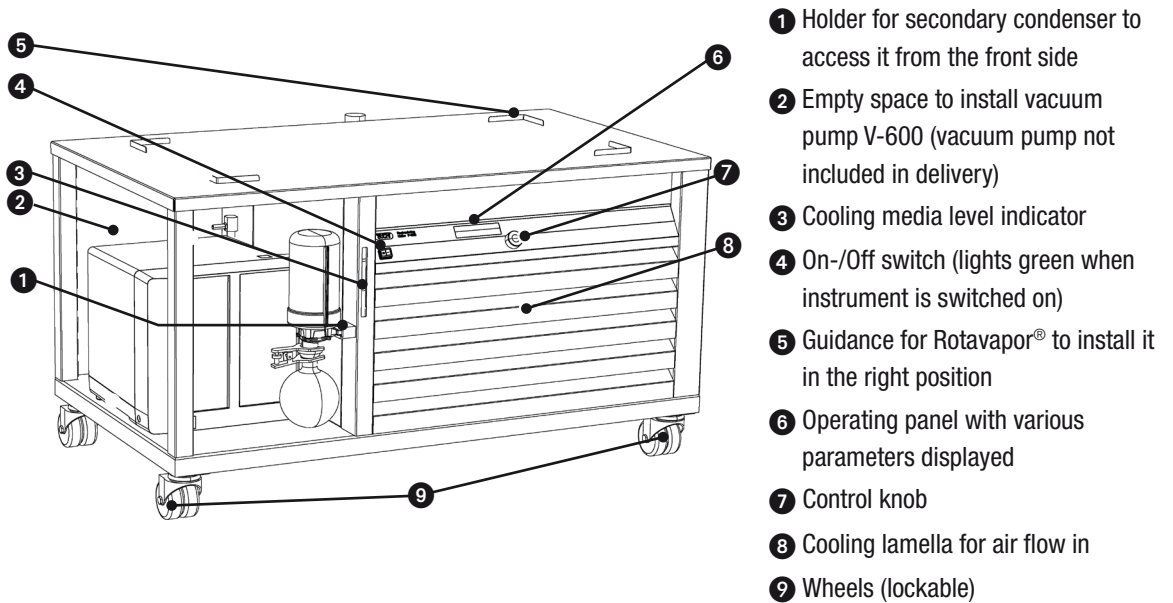

Display



- | | |
|--------------------------|--|
| ① Operating status | ④ Connection symbol - device is being controlled via a BUCHI interface |
| ② Actual temperature | ⑤ Options activated if control knob is pressed |
| ③ Set temperature locked | ⑥ Set temperature |

This section gives examples of typical instrument applications and instructions on how to operate the instrument properly and safely. See also section 2.5 “Product safety” for general warnings.

Level indicator



- ① Lower black line: minimum filling level
- ② Upper black line: maximum filling level
- ③ The floating ball: indicates the actual filling level of cooling liquid

Rear side

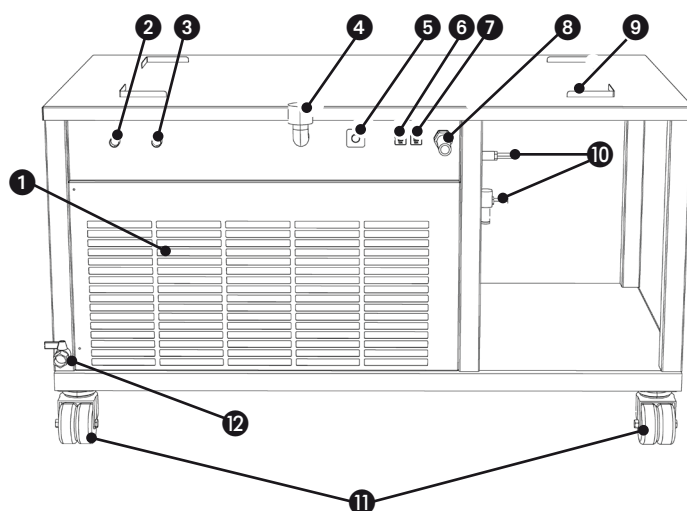

- ❶ Slots for air flow out
- ❷ Main cooling medium flow IN
- ❸ Main cooling medium flow OUT
- ❹ Filling connection for cooling medium
- ❺ COM connection to connect Chiller to the Rotavapor® R-220 Pro
- ❻ Resettable fuse
- ❼ Resettable fuse
- ❽ Power cable (to be installed by an electrician or equivalent specialist)
- ❾ Rotavapor® guidances to install System in the right position.
- ❿ Cooling medium flow IN / OUT for second condenser (bypass it when no second condenser is installed)
- ⓫ Wheels (not lockable)
- ⓬ Drain of cooling medium

5.4 Electrical connections

The BUCHI Recirculating Chiller F-325 is aimed to be installed stationary and is not equipped with a power plug. The electrical installation must be performed by an electrician or equivalent specialist. After the installation procedure an electrical safety test must be performed to verify a safe system condition such as sufficient grounding.

The used mains circuit has to:

- provide the voltage that is given on the type plate of the instrument.
- be able to handle the load of the connected instruments.
- be equipped with adequate fuses and electrical safety measures, in particular proper grounding.
- The Chiller and the Rotavapor® should use different phases.

For details about the installation requirements, see the "Guide for electrical installation" document. See also technical data (section 3) of all components regarding the different minimum system requirements!

	<p>⚠ WARNING</p> <p>Death or serious burns by electric current at installation.</p> <ul style="list-style-type: none"> • The instrument must be installed by an electrician or equivalent specialist • After installation, the instrument must be tested for electrical safety
---	---

	NOTICE
	<p>Risk of instrument damage if mains supply is incorrect.</p> <ul style="list-style-type: none"> • External mains supply must meet the voltage given on the type plate • Check for proper grounding • Exchange defective cabling immediately • The max. load on the auxiliary power outlet socket must not exceed 100W!

NOTE

- Additional electrical safety measures such as residual current breakers may be necessary to meet local laws and regulations!
- External power switches (e.g. emergency stop switches) must meet IEC 60947-1 and IEC 60947-3 requirements. Such devices must be clearly labeled and accessible at any time.
- External connections and extension lines must be provided with a grounded conductor lead (3-pole couplings, cord or plug equipment). All used power cords used must meet the input power requirements.
- If you have a pump connected to the system the pump can be plugged into the power from the Recirculating Chiller F-325.

5.5 Preparing for operation

Prerequisites

- All parts must be clean and free of damage.
- Close the drain valve.

5.5.1 Installing the Rotavapor® on top of the Chiller

For installation of the Rotavapor® on the Chiller you need a transportation specialist. You need at least two people to lift the Rotavapor® onto the top of the Chiller Trolley. Mount four carry belts on the Rotavapor® feet . Install one of them on each end. Check for proper seating of the belts. Now lift the Rotavapor® evenly onto the Chiller Trolley.

	CAUTION
	<p>Risk of minor or moderate injury due to the heavy weight of the instrument.</p> <ul style="list-style-type: none"> • Utilize a second person to transport the instrument • Do not drop the instrument or its transport box • Place the instrument on a stable, even and vibration-free surface • Keep limbs out of crushing zone

5.5.2 Installing the hoses

	WARNING
	<p>Stumbling or falling due to improper installation of the cables and hoses.</p> <ul style="list-style-type: none"> • The length of the cables and hoses should be kept as short as possible • If possible, avoid installing cables and hoses in aisle areas • If installation of cables and hoses in aisle areas is unavoidable, use an adequate protective pad in order to avoid the danger of stumbling and damage

- Connect out flow and return flow connections of the Recirculating Chiller with the condenser of the rotary evaporator.

NOTE

Only use hoses which can withstand min. -20 °C and 2 bar pressure and secure them with the usual hose clamps.

Setup for a complete Rotavapor® system, includes second condenser on the Chiller and condenser on the Rotavapor®:

- Connect cooling medium flow IN / OUT for second condenser to the second condenser installed on the Chiller.
- Connect the main cooling medium flow OUT to the bottom inlet of the cooling coil of the Rotavapor®.
- Connect the main cooling medium flow IN to the top outlet of the cooling coil of the Rotavapor®.
- See also section 5.2 “Cooling water routing”.

5.5.3 Filling the cooling media tank

Do not connect and operate before filling with coolant. Mind the maximum fill level! We recommend a mixture of ethylene glycol/water at least 30/60, which does not freeze until -16 °C.

NOTE

If you have a large closed cycle cooling system (e.g. long hoses, many condensers connected to the system in series) fill the refrigerant tank to maximum level.

	NOTICE
	<p>Risk of instrument damage if wrong cooling medium is used.</p> <ul style="list-style-type: none"> • Check to ensure that the cooling medium is suitable for use at the desired cooling temperature and does not freeze at the working temperature

5.5.4 Installing the Vacuum Pump V-600

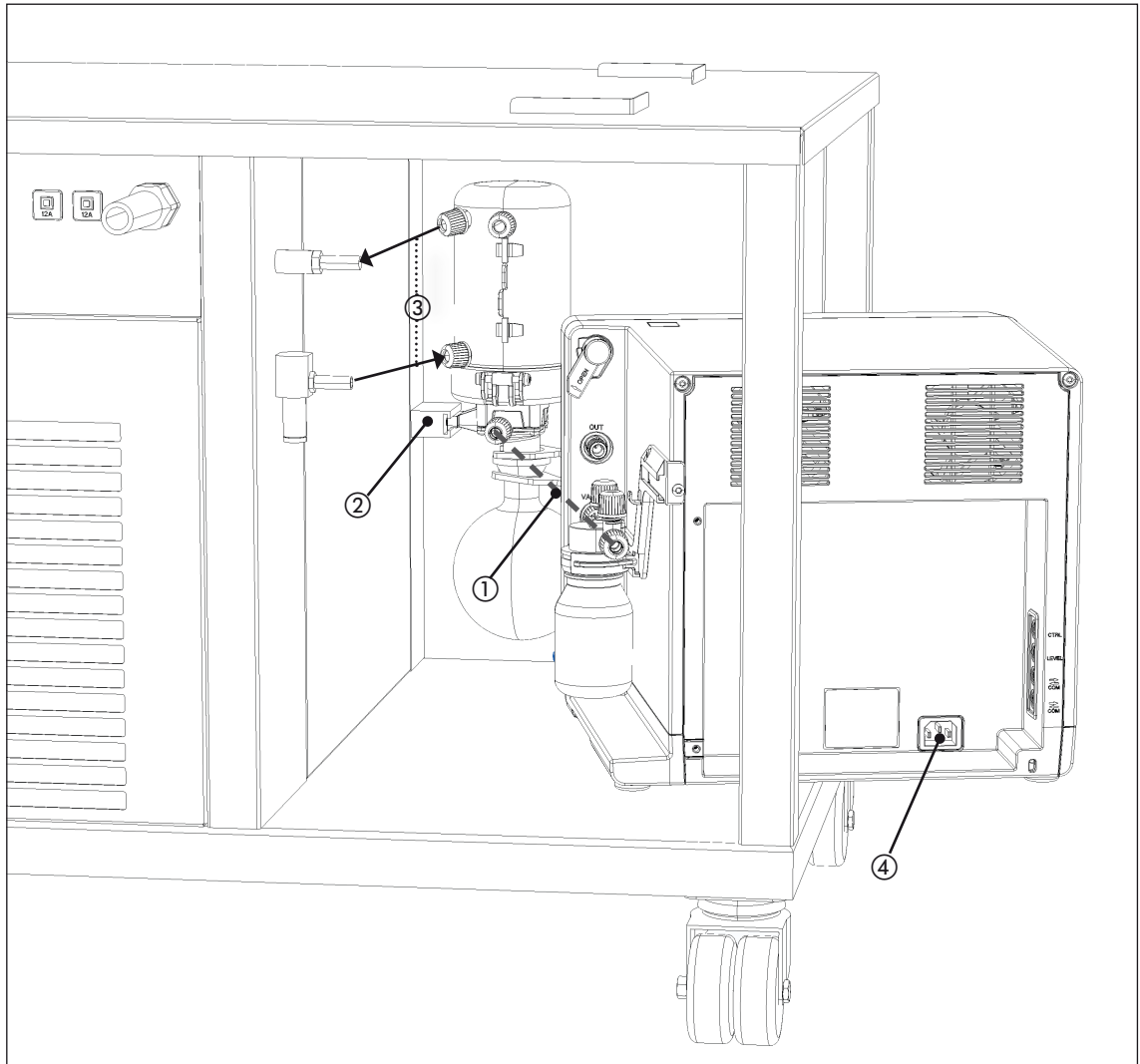

① FEP tubing

③ Tubing



② Holder

④ Power cable

- Insert secondary condenser into the holder ②.
- Connect the condenser with the enclosed tubing ③.
- Connect the pump outlet to the secondary condenser with the enclosed FEP tubing ①.
- Place the Vacuum Pump V-600 in the allocated space making sure that the tubing is not disconnected in the process.
- Connect the Vacuum Pump V-600 to the Rotavapor® R-220 Pro using the enclosed power cable ④.

6 Operation

6.1 Operating the Recirculating Chiller

	 WARNING
	<p>Danger of injury due to tipping or failure of the instrument due to vibrations.</p> <ul style="list-style-type: none"> • Before starting, the rollers of the instrument must be blocked

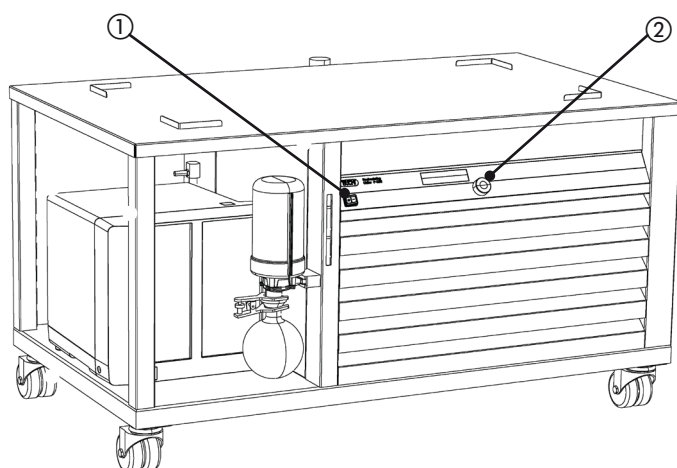

- Switch on the device by means of the On/Off switch ①.
- Check the fill level of the cooling media tank (see Chapter 6.2.3 "Filling the cooling media tank", page 19).
- Set the required temperature using the control knob ② and confirm the setting by briefly pressing and releasing the button.
- Start/stop the chilling process by pressing the control knob.

6.2 Operating the Recirculating Chiller with the Interface I-300 Pro

The Recirculating Chiller can also be externally controlled by an Interface I-300 Pro on the Rotavapor® R-220 Pro.

- Switch on the device by means of the On/Off switch (1).
- Connect the Rotavapor® R-220 Pro (see the relevant sections of the operation manual for the R-220 Pro.)
- Set the required temperature via the Interface I-300 Pro, see operation manual for I-300 Pro.
- Start/stop the chilling process via the Interface I-300 Pro, see operation manual for I-300 Pro.

6.3. Locking the set temperature

The recirculating chiller has a locking function that prevents the set temperature being inadvertently altered.

- To lock the set temperature, press and hold the control knob until the padlock symbol appears on the display.
- To cancel the lock function, press and hold the control knob again until the padlock symbol disappears.

7 Maintenance and repairs

This section gives instructions on maintenance work to be performed in order to keep the instrument in a good and safe working condition. All maintenance and repair work requiring the opening or removal of the instrument housing must be carried out by trained service personnel and only with the tools provided for this purpose.

NOTE

Use only genuine consumables and spare parts for any maintenance and repair work in order to assure warranty and continued system performance. Any modifications of the Recirculating Chiller or parts of it require the prior written permission of the manufacturer.

	WARNING
	<p>Death or serious burns by electric current.</p> <ul style="list-style-type: none"> • Switch off the instrument, disconnect the power cord and prevent unintentional restart before touching any of the elements inside the Recirculating Chiller • Do not spill liquids over the device

	NOTICE
	<p>Risk of housing and instrument damage by liquids and detergents.</p> <ul style="list-style-type: none"> • Do not spill liquids over the instrument or parts of it • Wipe off any liquids immediately • Use only ethanol or soapy water for cleaning

7.1 Customer service

Only authorized service personnel are allowed to open up the housing and/or perform repair work on the instrument which is not described in this manual. Authorization requires a comprehensive technical training and knowledge of possible dangers which might arise when working with the instrument. Such training and knowledge can only be provided by BUCHI.

Addresses of official BUCHI customer service offices are given on the BUCHI website under: www.buchi.com. If malfunctions occur on your instrument or you have technical questions or application problems, contact one of these offices.

The customer service offers the following:



- Spare part delivery
- Repairs
- Technical advice

7.2 General inspection and cleaning instructions

Check the housing for visible defects (switches, plugs, enclosure etc.) and clean it regularly under safe conditions with a damp cloth. Wipe off any splashes of aggressive chemicals immediately using a damp cloth in order to avoid any damage being caused to the coating on the housing. Ethanol as a cleaning agent is also possible to use.

Cleaning under safe conditions

- Switch off the Recirculating Chiller and unplug the power cord.
 - ➔ Let the system acclimate to ambient temperature completely!
- Perform cleaning actions with a damp cloth.
- Regularly clean lamella on front and rear side of the chiller with a damp cloth to remove dust, at least once a year.

	 WARNING
	<p>Fire hazard, overheating, or triggering of the over-temperature protection function as a result of a dirty air intake.</p> <ul style="list-style-type: none"> • Clean the air intake as needed, but at least 1 x per year.

Hoses

- Check the hoses for wear at least every six months.
- Exchange damaged hoses.

Cooling media tank

- Check prior to use the filling level of the Recirculating Chiller
- Exchange the cooling liquid once a year by means of the drain valve and renew.
 - ➔ If you use a ethylene glycol/water mixture as cooling media you can drain it to the sink.

8 Troubleshooting

8.1 Error message display

The Recirculating Chiller shows a fault code on the display if a malfunction has occurred on the device.

8.2 Faults and rectifying them

Prior to all repair work and fault rectification, e.g. fuse replacement, the recirculating chiller is to be disconnected from the power supply by unplugging the power cord from the power outlet.

8.2.1 Indication of faults on the display

Indication of faults on the display		
Fault Code	Fault	Remedy
E01	Temperature sensor defective	<ul style="list-style-type: none"> Switch off the device and allow it to cool down.
E02	Temperature error	<ul style="list-style-type: none"> Clean the air intake (see Chapter 7.2 "General inspection and cleaning instructions", page 23). Switch the appliance on again. Contact Customer Service if the problem cannot be rectified.
E03	Coolant tank empty or level too low, pump malfunction	<ul style="list-style-type: none"> Switch off the device and allow it to cool down. Top up coolant level (see Chapter 6.2.3 "Filling the cooling media tank", page 19). Switch the appliance on again. Contact Customer Service if the problem cannot be rectified.
E04	Compressor pressure fault	<ul style="list-style-type: none"> Switch off the device and allow compressor to cool down. Switch the appliance on again. Contact Customer Service if the problem cannot be rectified.
E05	Data error	<ul style="list-style-type: none"> Switch the appliance off and then on again. Contact Customer Service if the problem cannot be rectified.
E06	Electronic circuitry overheated	<ul style="list-style-type: none"> Switch off the device and allow it to cool down. Clean the air intake (see Chapter 7.2 "General inspection and cleaning instructions", page 14). Switch the appliance on again. Contact Customer Service if the problem cannot be rectified.

8.2.2 Other malfunctions

Other malfunctions		
Fault	Cause	Remedy
Device chilling function cuts out	Overheat cutout has tripped	<ul style="list-style-type: none"> Switch off the device and allow it to cool down. Check whether the installation site meets the required conditions. In particular, the clearance around the device must be sufficient to allow the air to circulate. See also Chapter 5.1 "Installation site", page 14.

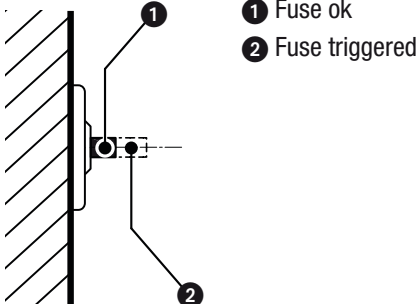
Malfunctions and their remedies	
Problem	Remedy
F-325 does not work	<p>Switch off the unit and let it cool down. Gently push the resettable fuses back into prestressed position when fuses are activated. Call service if the problem persists.</p> 

9 Shutdown, storage, transport and disposal

This section instructs how to shut down and to pack the instrument for storage or transport. Specifications for storage and shipping conditions can also be found listed here.

NOTE

See manufacturer safety data sheet (chapter 11) about the refrigerant!

	! WARNING
	<p>Poisoning or serious injuries through contact with or incorporation of harmful substances.</p> <ul style="list-style-type: none"> • Wear safety goggles • Wear safety gloves • Wear a laboratory coat • Clean the instrument and all accessories thoroughly to remove possibly dangerous substances • Do not clean dusty parts with compressed air • Store the instrument and its accessories in a dry place in the original packaging

9.1 Storage and transport

Switch off the instrument and unplug the unit. To disassemble the Recirculating Chiller follow the installation instructions in section 5 in reverse order. Clean the instrument thoroughly! The cooling liquid is to be drained before storage or shipping. The instrument is to be stored in the original packaging in a dry location. Shipping is also to be done in the original packaging and in upright position only.

	NOTICE
	<p>Defective instrument due to improper packaging or improper transport.</p> <ul style="list-style-type: none"> • Pack the instrument for safe transport with new, suitable packaging material • In particular, secure the compressor for transport • Secure the properly packaged instrument on a pallet for transport

NOTE

- After transport, wait at least 1 hour before switching on the chiller! Within this time the refrigerant gathers in the compressor, avoiding damage of the compressor.
- Drain the cooling medium thoroughly and close the drain cock subsequently.

9.2 Disposal

Disposal of instrument

For instrument disposal in an environmentally friendly manner, a list of materials is given in section 3.2. This helps to ensure that the components can be separated and recycled correctly by a specialist for disposal.



You have to follow valid regional and local laws concerning disposal. For help, please contact your local authorities!

NOTE

When returning the instrument to the manufacturer for repair work, please copy and complete the health and safety clearance form on the following page and enclose it with the instrument.

Disposal of Refrigerant R134a

The cooling medium R134a must be destroyed in an approved facility, which is equipped to absorb and neutralize acidic gases and other toxic processing products.

 	<p>⚠ CAUTION</p> <p>Freeze-burns and eye injuries through direct contact with R134a.</p> <ul style="list-style-type: none"> • Avoid contact with skin and eyes • Always wear safety goggles • Always wear safety gloves • Hoses can be additionally insulated (see optional offering for hose insulation)
---	--

10 Spare parts

This section lists spare parts, accessories and options including their ordering information. Only order spare parts and consumables from BUCHI to maintain the warranty status and to assure best performance and reliability of the system and affected components. Any modifications to the spare parts used are only allowed with the prior written permission of the manufacturer.

Always state the product designation, instrument serial and part numbers for warranty clearance when ordering spare parts!

10.1 Enclosed parts

Enclosed parts list	
Mains cables	Single phase, open cable
Control cable RJ45, 2m	✓
Hose D10/15 3m, 2×	✓
Hose nipple 13.5mm, 2×	✓
Screw cap M16x1, 4×	✓
Hose clamp, 4×	✓
Operation Manual	✓

10.2 Instrument configuration

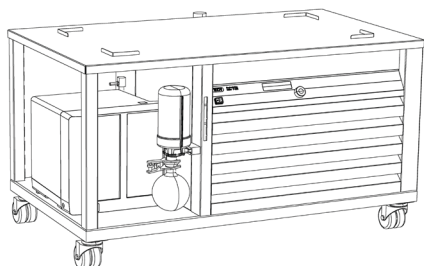

Content

Instrument version:	Order no.
BUCHI Recirculating Chiller	
F-325 Model 2500 controlled	11F32501

10.3 Spare parts, optional accessories

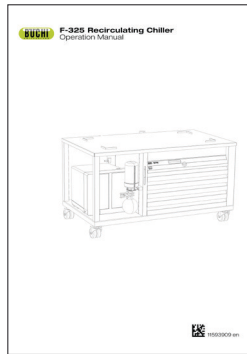

Spare parts

Description	Order no.
Operation Manual	
English	11593909
German	11593910
French	11593911
Italian	11593912
Spanish	11593913

Interface cable	11058707
-----------------	----------

Tubing, PVC, x 10/15 mm, transparent, per m	027146
--	--------

Hose nipples, 9.5mm	046792
---------------------	--------

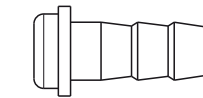

Hose nipples, 13.5mm	040329
----------------------	--------

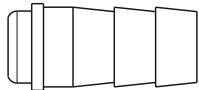

Spare parts

Screw cap M16x1 Rf	019889
--------------------	--------

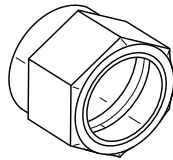

Hose clamp	022352
------------	--------

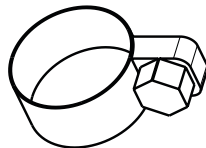

Insulation for hose D6/15	11056888
---------------------------	----------

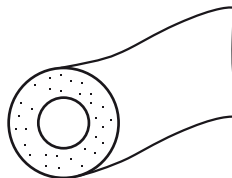

11 Declarations and requirements

11.1 FCC requirements (for USA and Canada)

English:

This equipment has been tested and found to comply with the limits for a Class A digital device, pursuant to both Part 15 of the FCC Rules and the radio interference regulations of the Canadian Department of Communications. These limits are designed to provide reasonable protection against harmful interference when the equipment is operated in a commercial environment.

This equipment generates, uses and can radiate radio frequency energy and, if not installed and used in accordance with the instruction manual, may cause harmful interference to radio communications. Operation of this equipment in a residential area is likely to cause harmful interference in which case the user will be required to correct the interference at his own expense.

Français:

Cet appareil a été testé et s'est avéré conforme aux limites prévues pour les appareils numériques de classe A et à la partie 15 des réglementations FCC ainsi qu'à la réglementation des interférences radio du Canadian Department of Communications. Ces limites sont destinées à fournir une protection adéquate contre les interférences néfastes lorsque l'appareil est utilisé dans un environnement commercial.

Cet appareil génère, utilise et peut irradier une énergie à fréquence radioélectrique, il est en outre susceptible d'engendrer des interférences avec les communications radio, s'il n'est pas installé et utilisé conformément aux instructions du mode d'emploi. L'utilisation de cet appareil dans les zones résidentielles peut causer des interférences néfastes, auquel cas l'exploitant sera amené à prendre les dispositions utiles pour palier aux interférences à ses propres frais.

11.2 Health and safety clearance

Health and Safety Clearance

Declaration concerning safety, potential hazards and safe disposal of waste.

For the safety and health of our staff, laws and regulations regarding the handling of dangerous goods, occupational health and safety regulations, safety at work laws and regulations regarding safe disposal of waste (e.g. chemical waste, chemical residues or solvents) require that this form must be completed, signed and enclosed to every return shipment of equipment or defective parts.

Instruments or parts will not be accepted if this declaration is not present.

Equipment

Model:

Part/Instrument no.:

1.A Declaration for non dangerous goods

We assure that the returned equipment:

- is unused and new.
- has not been exposed to toxic, corrosive, biologically active, explosive, radioactive or other dangerous matters. No hazard emanates from the device!
- is free of contamination (e.g. that chemicals, solvents or residues of pumped media have been drained prior to shipment). No hazard emanates from the device!



1.B Declaration for dangerous goods

Exhaustive list of dangerous substances the equipment has been exposed to:

Chemical, substance	Danger classification

We assure that:

- all hazardous substances (e.g. toxic, corrosive, biologically active, explosive, radioactive etc.) which have been processed or been in contact with the equipment are listed above.
- the equipment has been cleaned, decontaminated and is free of transmissible agents such as hazardous fungi, bacteria, viruses etc. If sterilization is applicable, all in- and outlets of the equipment have been properly sealed the process.

2. Final Declaration

We hereby declare that:

- we know all about the substances which have been in contact with the equipment and all questions have been answered correctly.
- we have taken all measures to prevent potential risks that might emanate from the delivered equipment.
- this document will be attached clearly visible and securely to the outside of the transport box.

Company name or stamp: _____

Place, date: _____

Name (print), job title (print): _____

Signature: _____

BUCHI Affiliates:

Europe

Switzerland/Austria

BÜCHI Labortechnik AG
CH – 9230 Flawil
T +41 71 304 63 03
F +41 71 304 66 06
buchi@buchi.com
www.buchloom.com

Italy

BUCHI Italia s.r.l.
IT – 20010 Comaredo (MI)
T +39 02 834 60 11
F +39 02 576 12 855
italia@buchi.com
www.buchloom.com/it

Benelux

BÜCHI Labortechnik GmbH
Branch Office Benelux
NL – 3342 GT Hardrik-bos-Ambacht
T +31 78 694 94 20
F +31 78 694 94 30
benelux@buchloom.com
www.buchloom.com/bx-en

Russia

BUCHI Russia/CIS
Russia 127287 Moscow
T +7 495 36 36 405
F +7 495 96 10 620
russia@buchi.com
www.buchloom.com/ru-ru

France

BUCHI Sarl
FR – 94556 Rungis Cedex
T +33 1 56 70 62 50
F +33 1 46 86 00 31
france@buchi.com
www.buchloom.com/fr-fr

United Kingdom

BUCHI UK Ltd.
GB – Oldham OL9 9QL
T +44 161 633 1000
F +44 161 633 1007
uk@buchi.com
www.buchloom.com/gb-en

Germany

BÜCHI Labortechnik GmbH
DE – 45127 Essen
T +800 414 0 414 0 (Toll Free)
T +49 201 747 49 0
F +49 201 747 49 20
deutschland@buchloom.com
www.buchloom.com/de-de

Germany

BÜCHI NIR-Online
DE – 69190 Walldorf
T +49 6227 73 26 60
F +49 6227 73 26 70
nir-online@buchi.com
www.nir-online.de

America

Brazil

BUCHI Brasil Ltda.
BR – Valinhos SP 13271-200
T +55 19 3649 1201
F +55 19 3649 2007
brazil@buchloom.com
www.buchloom.com/br-pt

USA/Canada

BUCHI Corporation
US – New Castle, DE 19720
T +1 877 662 8244 (Toll Free)
T +1 302 662 3000
F +1 302 662 8777
us-sales@buchi.com
www.buchloom.com/us-en

Asia

China

BUCHI China
CN – 200052 Shanghai
T +86 21 6260 3366
F +86 21 5230 8821
china@buchi.com
www.buchloom.com/cn-zh

India

BUCHI India Private Ltd.
IN – Mumbai 400 055
T +91 22 657 75400
F +91 22 657 16956
india@buchi.com
www.buchloom.com/in-en

Indonesia

PT. BUCHI Indonesia
ID – Tangerang 15321
T +62 21 637 62 16
F +62 21 637 62 17
indonesia@buchi.com
www.buchloom.com/id-in

Japan

Nihon BUCHI K.K.
JP – Tokyo 110-0008
T +61 3 3621 4777
F +61 3 3621 4555
nihon@buchi.com
www.buchloom.com/jp-ja

Korea

BUCHI Korea Inc.
KR – Seoul 153-762
T +82 2 6718 7500
F +82 2 6718 7509
korea@buchi.com
www.buchloom.com/kr-ko

Malaysia

BUCHI Malaysia Sdn. Bhd.
MY – 47301 Petaling Jaya,
Selangor
T +60 3 7832 0310
F +60 3 7832 0309
malaysia@buchi.com
www.buchloom.com/my-en

Singapore

BUCHI Singapore Pte. Ltd.
SG – Singapore 609919
T +65 6565 1175
F +65 6565 7047
singapore@buchi.com
www.buchloom.com/sg-en

Thailand

BUCHI (Thailand) Ltd.
TH – Bangkok 10600
T +66 2 962 08 51
F +66 2 962 08 54
thailand@buchi.com
www.buchloom.com/th-th

BUCHI Support Centers:

South East Asia

BUCHI (Thailand) Ltd.
TH-Bangkok 10600
T +66 2 862 08 51
F +66 2 862 08 54
bacc@buchi.com
www.buchloom.com/th-th

Middle East

BÜCHI Labortechnik AG
UAE – Dubai
T +971 4 313 2860
F +971 4 313 2861
middleeast@buchi.com
www.buchloom.com

Latin America

BUCHI Latinoamérica Ltda.
BR – Valinhos SP 13271-200
T +55 19-3949 1201
F +55 19-3949 2007
latinoamerica@buchi.com
www.buchloom.com/la-es

We are represented by more than 100 distribution partners worldwide.
Find your local representative at: www.buchi.com